

MeasumaX

Measuring tools for now and the future

Rechargeable Digital Calipers



 **RECHARGEABLE**

150mm / 6" 31-175

200mm / 8" 31-176

300mm / 12" 31-177



Edition 1.1

(Date: 07/26)

Instruction Manual



Waterproof

Up to 1m for 30 minutes



Magnetic Charging

USB-A Magnetic Cable

4-Way Measuring



Inside



Outside



Step

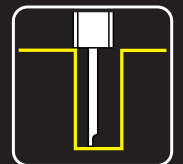

Depth

Features

- Metric / Imperial / Fraction measuring modes
- Long battery life with low battery alert
- Fast charging in less than three hours
- Auto off function

Includes

- Magnetic charge cable with USB-A plug
- Deluxe storage case

Contains Rechargeable Lithium-Ion Battery

1. Product Identification

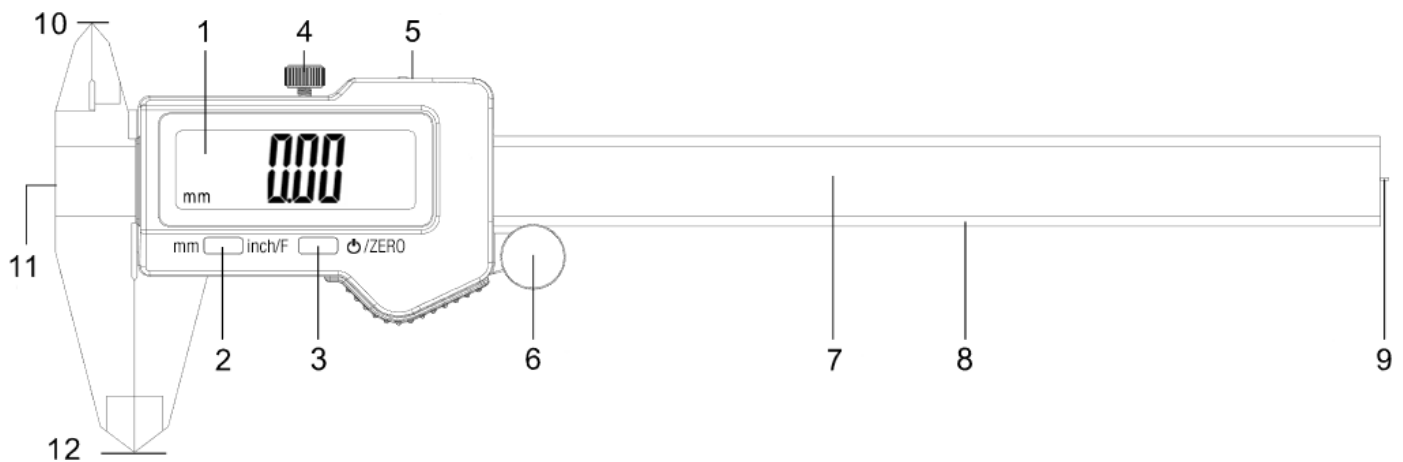

- | | |
|--|--|
| <ol style="list-style-type: none"> 1. LCD screen 2. MODE Button: Short-press for inch/metric conversion, Long-press for Fraction conversion (0.01mm / 0.005mm) 3. 0/ZERO Button: Short-press to turn on, Short-press reset zero when power on, Long-press more than 3 seconds to turn off. 4. Locking Screw: Hand screw clockwise to lock the caliper position, screw counterclockwise to release. 5. Magnetic Charging Port | <ol style="list-style-type: none"> 6. Thumb Roller 7. Scale 8. Beam 9. Depth Measurement Rod: measuring depth 10. Internal Jaw: measuring Internal dimension 11. Step Measurement: measuring step dimension 12. External Jaw: measuring external dimension |
|--|--|

2. 4-Way Measurement Operation

1. Turn the locking screw counterclockwise to unlock the caliper. Move the slider smoothly using the thumb roller.
2. Press the 0/ZERO button and check that the LCD display and all button functions operate correctly.
3. Wipe the measuring faces clean to remove any dirt or debris.
4. Close the jaws gently using light pressure, then press the 0/ZERO button to zero the display.
5. The caliper is now ready for use. Measure the workpiece using the appropriate measuring method:

Outside Measurement – Use the lower jaws.

Inside Measurement – Use the upper jaws.

Depth Measurement – Extend the depth rod from the end of the caliper.

Step Measurement – Use the rear step measuring faces.

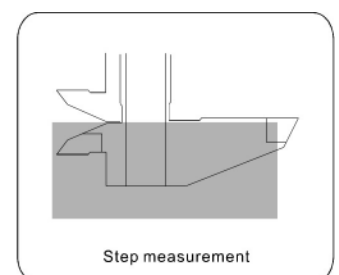
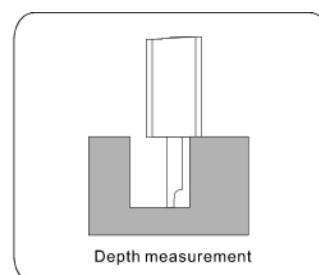
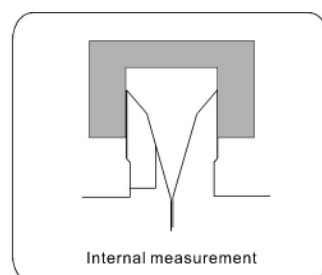
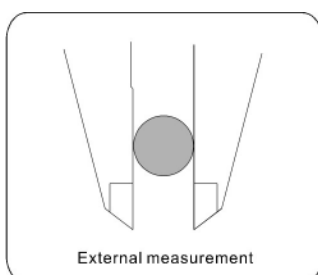

3. Product Characteristics

Range of Measurement

0-150mm/0-6" / Accuracy: 0.02mm/0.001"

0-200mm/0-8" / Accuracy: 0.03mm/0.0015"

0-300mm/0-12" / Accuracy: 0.03mm/0.0015"

Resolution: 0.01mm/0.0005" (0.005mm/0.0005")

Working temperature: 0-40°C

Storage and transportation: -20-70°C

Environmental humidity: unlimited

1. Inductive measurement system
2. Protection grade: IP67 (Dust tight and fully waterproof)
3. Automatic power off, power on function. (Note: when the caliper no use for 8 hours, if you want to use the caliper again, Press and short press the ϕ /ZERO button to turn on.)
4. Magnetic charging with built-in rechargeable lithium battery

4. Magnetic Charging

The product uses a built-in recyclable rechargeable lithium battery, when the power is too low, to take out the magnetic charging cable in the package, adsorbing and connecting to magnetic port on the top of the caliper, and to connect USB interface in another end to power bank, power adapter or computer and so on.

1. When charging, the screen will display a battery charging sign
2. The charging sign will not flash after the battery is fully charged
3. Due to the magnetic polarity, the charging lead will only connect in the correct orientation. Do not force the connection.
4. Charging voltage: 5V
5. Charging head: 5V/0.45A
6. The battery takes approximately 3 hours to fully charge with 5 Volt, 2 Amps.
7. Do not charge directly when there is liquid in the charging port.
8. Please charge in a clean environment to avoid pollution and blockage of the charging port, which may affect its function.

5. Caution

Although you own the high-quality product, like any other electronic product, appropriate attention is necessary.











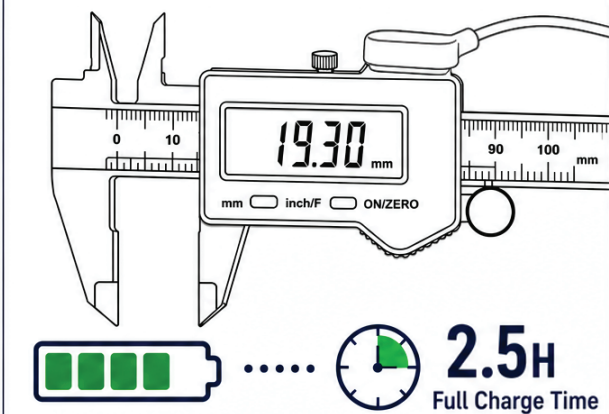



1. The product is a precise measuring tool, please avoid the product contacting with liquid, exposure in sunshine, do not disassemble or collide the product.
2. To ensure the good condition of measuring tool for long time, clean the oil contamination and liquid on the measuring tool with the soft cloth after using.

6. Troubleshooting

1. When displays twinkles (flashes) or readings are wrong on the screen, it shows the caliper is not guaranteed to work properly, please check the battery power of the caliper as this is an indication the caliper needs more charge.
2. If the screen is stuck in any interface and the function doesn't work, to restart the system and try. Long-press the **0/ZERO** button for about 20 seconds, then you need to release the button again and the system restarts.
3. If the screen is stuck at any interface during charging, it might be caused by unstable voltage or high charging temperature, please stop charging and check whether the screen is still stuck.
4. It is recommended not to use caliper whilst it is being charged.

RECHARGEABLE BATTERIES – CHARGING TIME & USAGE

For Rechargeable Vernier Calipers

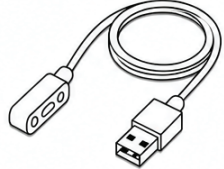
| | | | | | | |
|---|--|---|--|---|--|--|
| <p>CHARGING TIME</p>  <p>2.5H Full Charge Time</p> <p>* Use the provided magnetic charging cable.</p> | <p>BATTERY LIFE (PER FULL CHARGE)</p> <table border="1"> <tr> <td data-bbox="743 831 975 1243">  LIGHT USE 30 DAYS </td> <td data-bbox="975 831 1214 1243">  MEDIUM USE 15 DAYS </td> <td data-bbox="1214 831 1477 1243">  HEAVY USE 7 DAYS </td> </tr> </table> <p>* Usage time may vary depending on the operating environment and usage conditions.</p> | | |  LIGHT USE 30 DAYS |  MEDIUM USE 15 DAYS |  HEAVY USE 7 DAYS |
|  LIGHT USE 30 DAYS |  MEDIUM USE 15 DAYS |  HEAVY USE 7 DAYS | | | | |
| <p>BATTERY LIFETIME</p>  <p>500 CYCLES for full charge (One cycle = one full charge and discharge)</p> | <p>RESET</p>  <p>For hard re-set, hold the "ON/ZERO" button for more than 20 seconds.</p> | <p>AUTO OFF</p>  <p>NOTE: Vernier will automatically turn off when not used.</p> | <p>INFORMATION</p>  <p>The battery is designed to retain up to 70% of its original capacity after 500 full charge cycles under standard usage conditions.</p>  | | | |

IP54 vs IP67 (IP – Ingress Protection)

Solid Protection (First Digit)

IP54 (Rated 5): Dust protected. Some dust may enter, but it will not interfere with the device's satisfactory operation.

IP67 (Rated 6): Dust tight. Complete protection against the ingress of dust.

Liquid Protection (Second Digit)

IP54 (Rated 4): Protected against splashing water. Splashes from any direction will not cause harm, but it cannot handle sustained jets or submersion.

IP67 (Rated 7): Protected against temporary immersion. Devices can survive being submerged in up to 1 meter of fresh water for up to 30 minutes

IMPORTANT INFORMATION

3 Year Limited Warranty

MEASUMAX offers a three year limited warranty on this product.

MEASUMAX warrants to the original retail consumer and purchaser that this product will be free from defects in materials and workmanship for one year from the date the product was purchased ('the warranty period').

MEASUMAX will rectify any defect in materials or workmanship appearing within the warranty period by repairing or replacing the product. MEASUMAX will offer a refund of the purchase price if the product cannot be readily and quickly repaired or replaced. MEASUMAX reserves the right to determine whether the product contains any defects in materials or workmanship covered by this warranty.

The benefits offered by this warranty are in addition to your rights and remedies that may apply in law. Our goods come with guarantees that cannot be excluded under the Australian Consumer Law. You are entitled to a replacement or refund for a major failure and for compensation for any other reasonable foreseeable loss or damage. You are also entitled to have the goods repaired or replaced if the goods fail to be of acceptable quality and the failure does not amount to a major failure.

How to make a warranty claim

To make a claim under this warranty, the product or part must be returned for examination to an authorised service centre nominated by Hare and Forbes Machineryhouse together with proof of purchase such as the dated sales receipt and an explanation of the problem to be rectified.

Any costs incurred in making a claim under this warranty or returning the product to an authorised service centre is to be borne by the person making the claim unless otherwise agreed by Hare and Forbes Machineryhouse. If Hare and Forbes Machineryhouse determines the product contains a defect in materials or workmanship that is covered by this warranty then Hare and Forbes Machineryhouse will bear the cost of returning the repaired product or replacement product to the person making the claim. If We determines the product does not contain a defect in materials or workmanship covered by this warranty then the cost of returning the product will be at the expense of the person making the claim.

Warranty Exclusions

The warranty does not apply in the following cases:

- Unauthorised modification, disassembly, repair, or replacement of the whole unit or any internal components, or damage caused by improper or artificial handling.
- Damage resulting from incorrect installation, improper use, misuse, negligence, or accidental impact.



ENVIRONMENT PROTECTION

Recycle unwanted materials instead of disposing of them as waste. All tools, accessories and packaging should be sorted, taken to a recycling centre and disposed of in a manner which is compatible with the environment. When the product becomes completely unserviceable and requires disposal, drain any fluids (if applicable) into approved containers and dispose of the product and fluids according to local regulations.

Imported by

HARE & FORBES
MACHINERYHOUSE

Australian Distributor

Hare & Forbes
Machineryhouse
Sydney - Melbourne
Adelaide - Brisbane - Perth

Ph: 1300 202 200
www.machineryhouse.com.au

MACHINERYHOUSE

New Zealand Distributor

Machineryhouse
Auckland
Christchurch

Ph: 0800 142 326
www.machineryhouse.co.nz